



**PERTINGER**

# PRICE LIST

VALID FROM 1<sup>ST</sup> JANUARY 2022

ALL PRICES ARE EX-WORKS EXCLUDING VAT



# THE PERTINGER CONFIGURATOR CREATE OFFERS YOURSELF

**Register as a reseller** and use our online configurator to quickly and easily create an offer for your customer based on his or her wishes and ideas from your own computer, tablet or smartphone. You can then generate an order from the offer you have created.



**Calculate your stove  
online at [pertinger.com](https://www.pertinger.com)**

# PRICE LIST\*

VALID FROM 1<sup>ST</sup> JANUARY 2022

ALL PRICES ARE EX-WORKS EXCLUDING VAT

## INDEX

- 4** ÖKOALPIN WITHOUT OVEN
- 5** ÖKOALPIN WITH OVEN AT THE BOTTOM
- 6** ÖKOALPIN WITH LATERAL OVEN
- 8** VINTAGE KITCHEN STOVES
- 9** PELLET STOVES
- 10** PELLET HEATING STOVES
- 10** ACCESSORIES PELLET STOVES
- 11** HEATING STOVES
- 12** HEATING STOVES PLUS
- 13** REVERSE FLAME HEATING STOVES
- 14** HEATING STOVES ACCESSORIES
- 15** PREFABRICATED STOVES
- 17** ACCESSORIES FOR PREFABRICATED STOVES
- 19** CUSTOMIZATIONS AND ACCESSORIES
- 25** WORKTOP CLOSURE PANELS AND SPACER STRIPS
- 26** OPTIONALS
- 27** PROFESSIONAL STOVES
- 28** CABINETS
- 33** TAILOR-MADE STOVES
- 34** COMPONENTS FOR STOVES
- 35** EXTRACTOR HOODS
- 38** OVENS
- 38** HOBS
- 40** FLUE PIPES 2MM, MALE END
- 42** FLUE PIPES FOR PELLET STOVES
- 43** CLEANING AND MAINTENANCE PRODUCTS
- 46** GENERAL TERMS AND CONDITIONS
- 47** VARIATIONS

\* Pertinger srl reserves the right to make any changes to the price list without notice.

Subject to errors and misprints. This price list replaces all previous price lists and is valid until revoked.

# ÖKOALPIN

## WITHOUT OVEN

- High efficiency combustion chamber
- Connection for external air intake
- Satin-finished steel or glass-ceramic
- AIR SYSTEM fire protection
- Side panels in stainless steel, powder-coated (standard colours) or plastered
- Front railing
- Height-adjustable from 850 – 910 mm
- Self-closing drawer with integrated baseboard



### 50 Ökoalpin

- Device measurements(W x D x H) • 500 x 600 x 850-910 mm
- Nominal heating output • 6,0 kW

Trend	2.870,00 €
Dekor	3.180,00 €
Panorama	3.215,00 €



### 60 Ökoalpin

- Device measurements(W x D x H) • 600 x 600 x 850-910 mm
- Nominal heating power • 6,0 kW

Trend	3.025,00 €
Dekor	3.335,00 €
Panorama	3.370,00 €

# ÖKOALPIN

## WITH OVEN AT THE BOTTOM

- High efficiency combustion chamber
- Connection for external air intake
- Oven with double-pane glass door and internal light
- Baking tray and grid - telescopic pull-out
- Satin-finished steel or glass-ceramic hob
- Fire door with triple self-cleaning glass
- AIR SYSTEM fire protection
- Side panels in stainless steel, powder-coated (standard colours) or plastered
- Front railing
- Height-adjustable from 850 – 910 mm
- Self-closing drawer with integrated baseboard (not BU XL)



### 60BU Ökoalpin

- Device measurements (W x D x H) • 600 x 600 x 850-910 mm
- Nominal heating output • 8,0 kW
- Oven measurements (W x D x H) • 345 x 420 x 160 mm

Panorama ..... 3.650,00 €



### 60BU XL Ökoalpin

- Device measurements (W x D x H) • 600 x 600 x 850-910 mm
- Nominal heating output • 8,0 kW
- Oven measurements (W x D x H) • 345 x 420 x 250 mm

Panorama ..... 3.650,00 €



### 70BU Ökoalpin

- Device measurements (W x D x H) • 700 x 600 x 850-910 mm
- Nominal heating output • 8,0 kW
- Oven measurements (W x D x H) • 445 x 420 x 160 mm

Panorama ..... 3.875,00 €



### 70BU XL Ökoalpin

- Device measurements (W x D x H) • 700 x 600 x 850-910 mm
- Nominal heating output • 8,0 kW
- Oven measurements (W x D x H) • 445 x 420 x 250 mm

Panorama ..... 3.875,00 €

## Accessories Ökoalpin with oven at the bottom

Pelletbox, capacity ca. 5,5 kg, nominal heating output 10 kW ..... 550,00 €



# ÖKOALPIN

## WITH LATERAL OVEN

- High efficiency combustion chamber
- Connection for external air intake
- Oven on right or left side
- Oven with double-pane glass door, incl. baking tray and grid
- Satin-finished steel or glass-ceramic hob
- AIR SYSTEM fire protection
- Side panels in stainless steel, powder-coated (standard colours) or plastered
- Front railing
- Height-adjustable from 850 – 910 mm
- Self-closing drawer with integrated baseboard



### 70 Ökoalpin

- Device measurements (W x D x H) • 700 x 600 x 850-910 mm
- Nominal heating output • 7,0 kW
- Oven measurements (W x D x H) • 260 x 420 x 265 mm

Trend	3.660,00 €
Dekor	3.970,00 €
Panorama	4.005,00 €



### 70+5 Ökoalpin

- Device measurements (W x D x H) • 750 x 600 x 850-910 mm
- Nominal heating output • 7,0 kW
- Oven measurements (W x D x H) • 300 x 420 x 265 mm

Trend	3.740,00 €
Dekor	4.050,00 €
Panorama	4.090,00 €



### 80 Ökoalpin

- Device measurements (W x D x H) • 800 x 600 x 850-910 mm
- Nominal heating output • 8,0 kW
- Oven measurements (W x D x H) • 300 x 420 x 265 mm

Trend	3.820,00 €
Dekor	4.130,00 €
Panorama	4.170,00 €



### 90 Ökoalpin

- Device measurements (W x D x H) • 900 x 600 x 850-910 mm
- Nominal heating output • 8,0 kW
- Oven measurements (W x D x H) • 345 x 420 x 265 mm

Trend	3.965,00 €
Dekor	4.275,00 €
Panorama	4.315,00 €

# ÖKOALPIN

## WITH LATERAL OVEN

- High efficiency combustion chamber
- Connection for external air intake
- Oven on right or left side
- Oven with double-pane glass door, incl. baking tray and grid
- Satin-finished steel or glass-ceramic hob
- AIR SYSTEM fire protection
- Side panels in stainless steel, powder-coated (standard colours) or plastered
- Front railing
- Height-adjustable from 850 – 910 mm
- Self-closing drawer with integrated baseboard



### 100 Ökoalpin

- Device measurements (W x D x H) • 1.000 x 600 x 850-910 mm
- Nominal heating output • 8,0 kW
- Oven measurements (W x D x H) • 445 x 420 x 265 mm

Trend	4.125,00 €
Dekor	4.435,00 €
Panorama	4.475,00 €



### 110 Ökoalpin

- Device measurements (W x D x H) • 1.100 x 600 x 850-910 mm
- Nominal heating output • 8,0 kW
- Oven measurements (W x D x H) • 545 x 420 x 265 mm

Trend	4.305,00 €
Dekor	4.615,00 €
Panorama	4.655,00 €

# VINTAGE

- High efficiency combustion chamber
- Connection for external air intake
- Oven on right or left side incl. baking tray and grid
- Front, left and right railing
- Satin-finished steel hob with rings



## 80 Vintage

- Device measurements (W x D x H)
- Nominal heating output
- Oven measurements (W x D x H)
- 800 x 640 x 850 mm
- 8,0 kW
- 260 x 420 x 265 mm

4.405,00 €



## 90 Vintage

- Device measurements (W x D x H)
- Nominal heating output
- Oven measurements (W x D x H)
- 900 x 640 x 850 mm
- 8,0 kW
- 300 x 420 x 265 mm

4.570,00 €



## 100 Vintage

- Device measurements (W x D x H)
- Nominal heating output
- Oven measurements (W x D x H)
- 1.000 x 640 x 850 mm
- 8,0 kW
- 400 x 420 x 265 mm

4.735,00 €



## 110 Vintage

- Device measurements (W x D x H)
- Nominal heating output
- Oven measurements (W x D x H)
- 1.100 x 640 x 850 mm
- 8,0 kW
- 500 x 420 x 265 mm

4.895,00 €



# PELLET STOVES

- Connection for external air intake
- Oven on right side (device with oven)
- Oven with double-pane glass door and internal light (device with oven)
- Baking tray and grid - telescopic pull-out (device with oven)
- Fire door with double self-cleaning glass
- Satin-finished hob
- AIR SYSTEM fire protection
- Side panels in stainless steel, powder-coated (standard colours) or plastered
- Front railing
- Height-adjustable from 850 – 910 mm



## 60 Pellet

- Device measurements (W x D x H) • 600 x 600 x 850-910 mm
- Nominal heating power • 6,7 kW
- Capacity • 20 kg

Panorama

5.190,00 €



## 90 Pellet

- Device measurements (W x D x H) • 900 x 600 x 850-910 mm
- Nominal heating power • 9,0 kW
- Oven measurements (W x D x H) • 345 x 420 x 265 mm
- Capacity • 24 kg

Panorama

6.860,00 €

# PELLET

## HEATING STOVES

- Connection for external air intake
- Oven on right side (device with oven)
- Oven with double-pane glass door and internal light (device with oven)
- Fire door with double self-cleaning glass
- Satin-finished hob
- AIR SYSTEM fire protection
- Side panels in stainless steel, powder-coated (standard colours) or plastered
- Front railing
- Height-adjustable from 850 – 910 mm



### 60 Pellet Hydro

- Device measurements (W x D x H)
- Nominal heating power
- Capacity
- 600 x 600 x 850-910 mm
- 13,2 kW
- 20 kg

Panorama ..... 5.980,00 €



### 90 Pellet Hydro

- Device measurements (W x D x H)
- Nominal heating power
- Oven measurements (W x D x H)
- Capacity
- 900 x 600 x 850-910 mm
- 10,7 kW
- 345 x 420 x 265 mm
- 24 kg

Panorama ..... 7.615,00 €

# ACCESSORIES

## PELLET STOVES



### Pellet Tank

- Device measurements (W x D x H)
- Capacity
- 400 x 600 x 850-910 mm
- 55 kg

..... 2.260,00 €

### Other

Flexible, heat-insulated aluminum tube for heat channeling (d = 80 mm) ..... 40,00 €

System for adjacent-room heating (only for regular pellet stove) ..... 685,00 €

WiFi module for mobile app and remote maintenance ..... 184,00 €

# HEATING STOVES

- High efficiency combustion chamber
- Connection for external air intake
- Oven on right or left side (device with oven)
- Oven with double-pane glass door and internal light (device with oven)
- Baking tray and grid - telescopic pull-out (device with oven)
- Fire door with triple self-cleaning glass
- Satin-finished steel or glass-ceramic hob
- AIR SYSTEM fire protection
- Side panels in stainless steel, powder-coated (standard colours) or plastered
- Front railing
- Height-adjustable from 850 – 910 mm
- Pump control
- Self-closing drawer with integrated baseboard



## 60 Heating stove

- Device measurements (W x D x H)
- Nominal heating output
- 600 x 600 x 850-910 mm
- 14,0 kW

Panorama

5.655,00 €



## 80 Heating stove

- Device measurements (W x D x H)
- Nominal heating output
- Oven measurements (W x D x H)
- 800 x 600 x 850-910 mm
- 14,0 kW
- 260 x 420 x 265 mm

Panorama

6.280,00 €



## 90 Heating stove

- Device measurements (W x D x H)
- Nominal heating output
- Oven measurements (W x D x H)
- 900 x 600 x 850-910 mm
- 14,0kW
- 345 x 420 x 265 mm

Panorama

6.435,00 €



## 100 Heating stove

- Device measurements (W x D x H)
- Nominal heating output
- Oven measurements (W x D x H)
- 1.000 x 600 x 850-910 mm
- 14,0 kW
- 445 x 420 x 265 mm

Panorama

6.580,00 €

# PLUS

## HEATING STOVES

- High efficiency combustion chamber
- Adjustable grill (summer and winter mode)
- Connection for external air intake
- Oven on right or left side
- Oven with double-pane glass door and internal light
- Baking tray and grid - telescopic pull-out
- Fire door with triple self-cleaning glass
- Satin-finished steel or glass-ceramic hob
- AIR SYSTEM fire protection
- Side panels in stainless steel, powder-coated (standard colours) or plastered
- Front railing
- Height-adjustable from 850 – 910 mm
- Pump control
- Self-closing drawer with integrated baseboard



### 80 PLUS Heating stove

- Device measurements (W x D x H)
  - Nominal heating output
  - Maximal heating output
  - Oven measurements (W x D x H)
- 800 x 600 x 850-910 mm
  - 14,9 kW
  - 21,0 kW
  - 245 x 420 x 265 mm

Panorama

6.740,00 €



### 90 PLUS Heating stove

- Device measurements (W x D x H)
  - Nominal heating output
  - Maximal heating output
  - Oven measurements (W x D x H)
- 900 x 600 x 850-910 mm
  - 14,9 kW
  - 21,0 kW
  - 345 x 420 x 265 mm

Panorama

6.895,00 €



### 100 PLUS Heating stove

- Device measurements (W x D x H)
  - Nominal heating output
  - Maximal heating output
  - Oven measurements (W x D x H)
- 1.000 x 600 x 850-910 mm
  - 14,9 kW
  - 21,0 kW
  - 445 x 420 x 265 mm

Panorama

7.040,00 €

# REVERSE FLAME

## HEATING STOVES

- Reverse flame combustion/ lower combustion gasification
- Connection for external air intake
- Oven on right or left side
- Oven with double-pane glass door and internal light
- Baking tray and grid - telescopic pull-out
- Fire door with triple self-cleaning glass
- Satin-finished steel or glass-ceramic hob
- AIR SYSTEM fire protection
- Side panels in stainless steel, powder-coated (standard colours) or plastered
- Front railing
- Height-adjustable from 850 - 910 mm
- Pump control
- Self-closing drawer with integrated baseboard



### 80 Reverse flame heating stove

- Measurements (W x D x H) • 800x 600 x 850-910 mm
- Nominal heating output • 10,6 kW
- Oven measurements (W x D x H) • 245 x 420 x 265 mm

Panorama

6.885,00 €



### 90 Reverse flame heating stove

- Measurements (W x D x H) • 900 x 600 x 850-910 mm
- Nominal heating output • 10,6 kW
- Oven measurements (W x D x H) • 345 x 420 x 265 mm

Panorama

7.040,00 €



### 100 Reverse flame heating stove

- Device measurements (W x D x H) • 1.000 x 600 x 850-910 mm
- Nominal heating output • 10,6 kW
- Oven measurements (W x D x H) • 445 x 420 x 265 mm

Panorama

7.195,00 €

# ACCESSORIES

## HEATING STOVES



### Thermokit RTP (PLUS and reverse flame)

- Pump
- Anti-condensation valve
- Thermal discharge
- Safety valve
- Check valve
- Membrane expansion tank

..... 1.495,00 €



### Oven with swivel opening

Alternative to lateral opening

..... no extra cost

### Other

Differential temperature controller

..... 258,00 €



# PREFABRICATED STOVES

- High efficiency combustion chamber
- Connection for external air intake
- Oven on right or left side (device with oven)

- Oven with double-pane glass door incl. baking tray and grid (device with oven)
- Satin-finished steel or glass-ceramic hob
- Front railing



## 60 Prefabricated stove

- Device measurements (W x D x H) • 600 x 600 x 480 mm
- Nominal heating output • 6,0 kW

Trend ..... 2.380,00 €

Dekor ..... 2.590,00 €

Panorama ..... 2.730,00 €



## 80 Prefabricated stove

- Device measurements (W x D x H) • 800 x 600 x 480 mm
- Nominal heating output • 8,0 kW
- Oven measurements (W x D x H) • 260 x 420 x 265 mm

Trend ..... 3.355,00 €

Dekor ..... 3.565,00 €

Panorama ..... 3.705,00 €



## 90 Prefabricated stove

- Device measurements (W x D x H) • 900 x 600 x 480 mm
- Nominal heating output • 8,0 kW
- Oven measurements (W x D x H) • 300 x 420 x 265 mm

Trend ..... 3.510,00 €

Dekor ..... 3.715,00 €

Panorama ..... 3.860,00 €



## 100 Prefabricated stove

- Device measurements (W x D x H) • 1.000 x 600 x 480 mm
- Nominal heating output • 8,0 kW
- Oven measurements (W x D x H) • 300 x 420 x 265 mm

Trend ..... 3.790,00 €

Dekor ..... 4.000,00 €

Panorama ..... 4.140,00 €

# PREFABRICATED STOVES

- High efficiency combustion chamber
- Connection for external air intake
- Oven on right or left side (device with oven)
- Oven with double-pane glass door incl. baking tray and grid (device with oven)
- Satin-finished steel or glass-ceramic hob
- Front railing



## 100 XL Prefabricated stove

- Device measurements (W x D x H)
- Nominal heating output
- Oven measurements (W x D x H)
- 1.000 x 600 x 480 mm
- 8,0 kW
- 400 x 420 x 265 mm

Trend ..... 3.660,00 €

Dekor ..... 3.870,00 €

Panorama ..... 4.010,00 €



## 110 XL Prefabricated stove

- Device measurements (W x D x H)
- Nominal heating output
- Oven measurements (W x D x H)
- 1.100 x 600 x 480 mm
- 8,0 kW
- 500 x 420 x 265 mm

Trend ..... 3.815,00 €

Dekor ..... 4.025,00 €

Panorama ..... 4.165,00 €

# ACCESSORIES

## FOR PREFABRICATED STOVES

### THE PRECAST BASE WITH OR WITHOUT COVERING OF PLASTERING

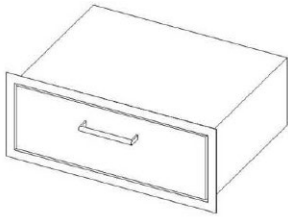

#### Self-closing drawer - Rectangular

60 Prefabricated cooking stove	697,00 €
80/90/100/100XL/110XL Prefabricated cooking stove	774,00 €

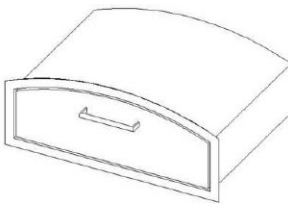

#### Self-closing drawer - Arched

60 Prefabricated cooking stove	1.096,00 €
80/90/100/100XL/110XL Prefabricated cooking stove	1.174,00 €

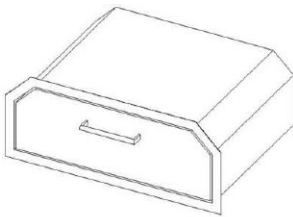

#### Self-closing drawer - Bevelled edge

60 Prefabricated cooking stove	898,00 €
80/90/100/100XL/110XL Prefabricated cooking stove	974,00 €

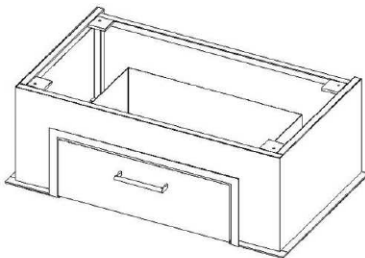

#### Base with drawer - Rectangular

60 Prefabricated cooking stove	1.022,00 €
80 Prefabricated cooking stove	1.119,00 €
90 Prefabricated cooking stove	1.166,00 €
100/100XL Prefabricated cooking stove	1.213,00 €
110XL Prefabricated cooking stove	1.260,00 €

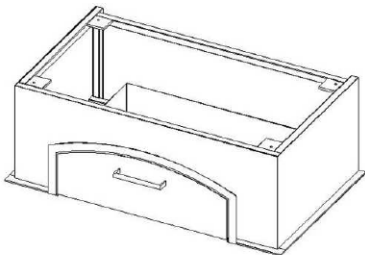

#### Base with drawer - Arched

60 Prefabricated cooking stove	1.423,00 €
80 Prefabricated cooking stove	1.518,00 €
90 Prefabricated cooking stove	1.565,00 €
100/100XL Prefabricated cooking stove	1.612,00 €
110XL Prefabricated cooking stove	1.659,00 €

# ACCESSORIES

## FOR PREFABRICATED STOVES

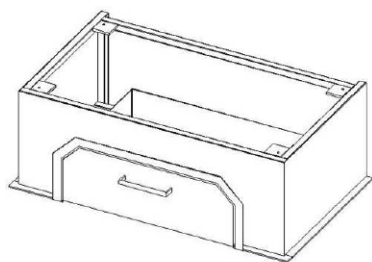

### Prefabricated base with drawer - bevelled version

60 Prefabricated cooking stove	1.224,00 €
80 Prefabricated cooking stove	1.318,00 €
90 Prefabricated cooking stove	1.365,00 €
100/100XL Prefabricated cooking stove	1.413,00 €
110XL Prefabricated cooking stove	1.455,00 €

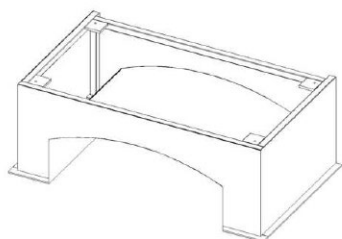

### Prefabricated base - arched version

60 Prefabricated cooking stove	498,00 €
80 Prefabricated cooking stove	537,00 €
90 Prefabricated cooking stove	574,00 €
100/100XL Prefabricated cooking stove	613,00 €
110XL Prefabricated cooking stove	655,00 €

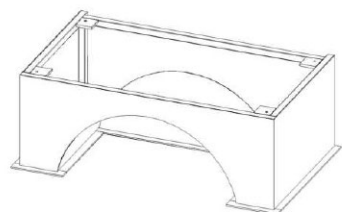

### Prefabricated arched base

60 Prefabricated cooking stove	498,00 €
80 Prefabricated cooking stove	537,00 €
90 Prefabricated cooking stove	574,00 €
100/100XL Prefabricated cooking stove	613,00 €
110XL Prefabricated cooking stove	655,00 €

### Other

AIR SYSTEM fire protection for prefabricated stove (+5 cm) , per side	338,00 €
Fitting of customer's tiles	415,00 €
Prefabricated stove with masonry aesthetics	1.069,00 €
Prefabricated stove with masonry aesthetics and finishing coat	1.237,00 €

# CUSTOMIZATIONS

## AND ACCESSORIES

VINTAGE, PELLET AND PREFABRICATED KITCHENSTOVES ON REQUEST

### One-time customization charge

To be applied only to the first adaptation of the standard frame ..... 132,00 €

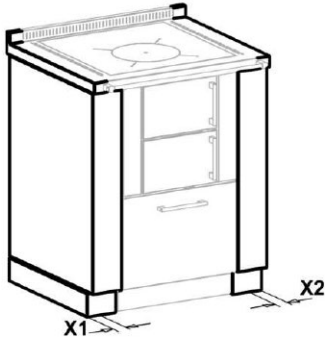

### Seamless broadening of stove width

The device will be equipped with fixed base instead of a height-adjustable base.

One-time customization charge (to be applied): 132,00 €

on one side: "X1" or "X2" up to 100 mm ..... 491,00 €

on both sides: "X1" and "X2" up to 100 mm ..... 864,00 €

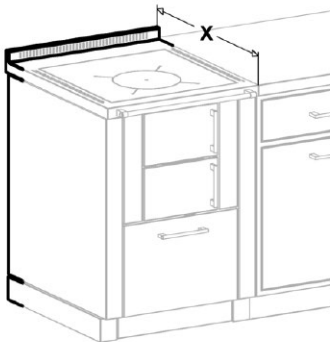

### Modification of stove depth

The side panel is extended with a separate stainless steel strip.

One-time customization charge (to be applied): 132,00 €

"X" from 600 to 800 mm (stainless steel strips) ..... 381,00 €

"X" from 600 to 800 mm - device free-standing on one side ..... 491,00 €

"X" from 600 to 800 mm - device free-standing on two sides ..... 600,00 €

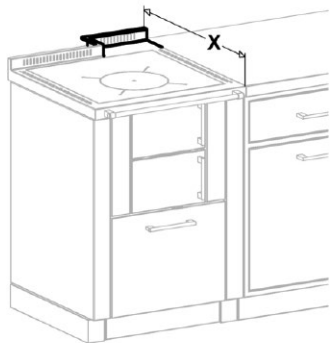

### Customized notch

One-time customization charge (to be applied): 132,00 €

Corner for the flue ..... 128,00 €

"X" from 600 to 800 mm ..... 381,00 €

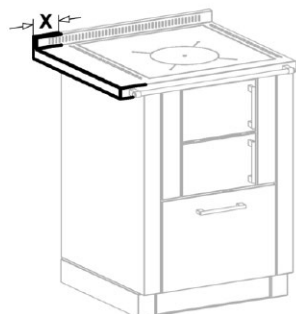

### Modification of frame width

One-time customization charge (to be applied): 132,00 €

"X" up to 400 mm ..... 267,00 €

"X" up to 800 mm ..... 406,00 €

"X" up to 1200 mm ..... 539,00 €

# CUSTOMIZATIONS

## AND ACCESSORIES

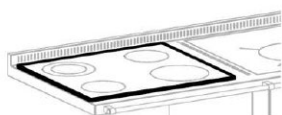

### Cut-out for hob

Cut-out for resting/ top-mounted hob	112,00 €
Cut-out for flush fitted hob	372,00 €

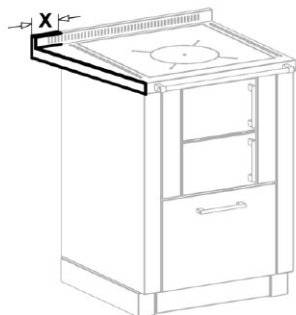

### Adaptation back side

One-time customization charge (to be applied): 132,00 €

"X" up to 400 mm	267,00 €
"X" up to 800 mm	406,00 €
"X" up to 1200 mm	539,00 €

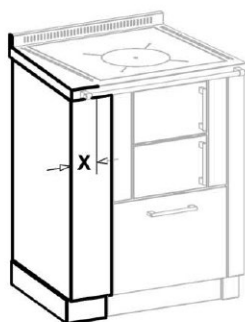

### Seamless adaptation front side

The device will be equipped with a fixed base instead of a height-adjustable base

One-time customization charge (to be applied): 132,00 €

Modification frame, side panel and base	491,00 €
---	----------

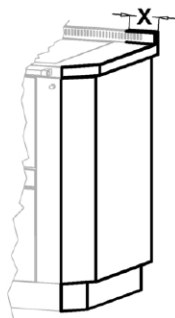

### Side panel with sloping edge

The device will be equipped with fixed base instad of a height-adjustable base.

One-time customization charge (to be applied): 132,00 €

"X" = 100 mm	773,00 €
--------------	----------

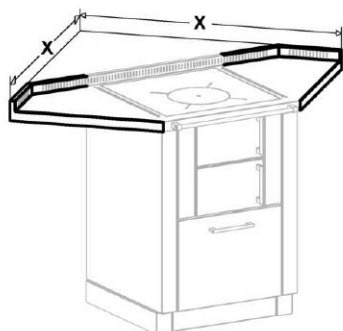

### Corner frame

One-time customization charge (to be applied): 132,00 €

Information on length of "X" on request	811,00 €
---	----------



# CUSTOMIZATIONS

## AND ACCESSORIES

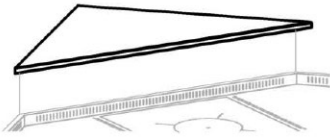

### Separate stainless steel corner closure

in combination with corner frame

355,00 €

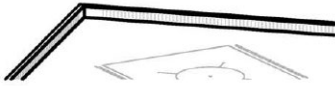

### Level stainless steel corner closure

in combination with corner frame

355,00 €

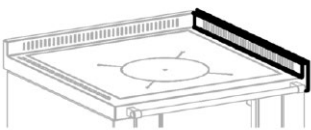

### Frame angle

One-time customization charge (to be applied): 132,00 €

Increase of plate angle height up to 300 mm 117,00 €

Frame angle left and/or right up to 40 mm, per side 117,00 €

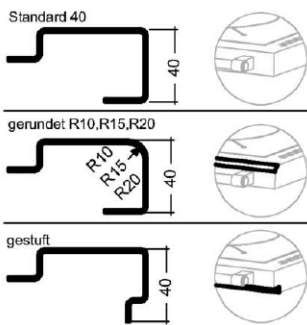

### Frame edge modification

Frames with a 30 mm or 40 mm worktop and a R15 or R20 radius cannot be equipped with RH05 railing supports; in these cases, we recommend the use of the RH03 supports.

One-time customization charge (to be applied): 132,00 €

Front-flush 146,00 €

Staged 146,00 €

Rounding R10, R15, R20 146,00 €



### Railing

Left and/or right, per side 115,00 €

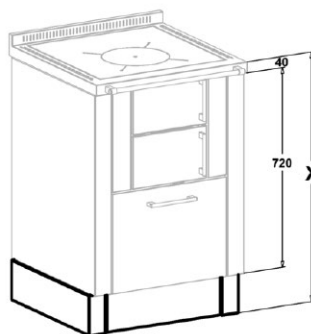

### Kitchen stove height

The device will be equipped with fixed base instead of a height-adjustable base.

"X" exceeding 910 mm 184,00 €

# CUSTOMIZATIONS

## AND ACCESSORIES

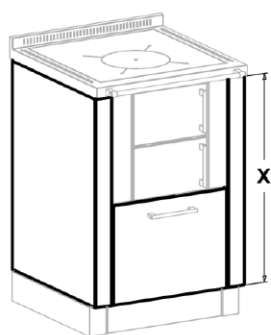

### Corpus and base height

The device will be equipped with fixed base instead of a height-adjustable base.  
Not possible with pellet stoves

"X" exceeding 720 mm, base customized height ..... 522,00 €

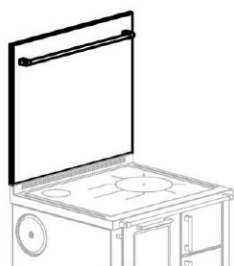

### Back panel in stainless steel

Bar for kitchen utensils ..... 120,00 €

Kitchen stove width up to 750 mm ..... 439,00 €

Kitchen stove width up to 1000 mm ..... 510,00 €

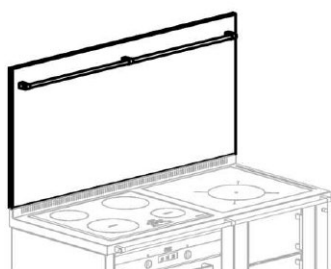

### Back panel in stainless steel

Bar for kitchen utensils ..... 133,00 €

For combined monoblocs up to 1500 mm ..... 578,00 €

For combined monoblocs up to 2000 mm ..... 647,00 €



### Fire door with triple self-cleaning glass

Included with the Panorama version

..... 352,00 €

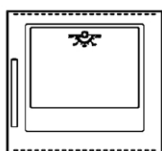

### Oven door with lateral opening

Included for kitchen stoves with heat exchanger

..... 270,00 €

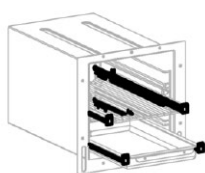

### Telescopic guides with full extraction for oven

Included for the Ökoalpin kitchen stoves with oven at the bottom and kitchen stoves with heat exchanger.

For all kitchen stoves with oven - kitchen stove depth 600 mm (per pair) ..... 83,00 €

# CUSTOMIZATIONS

## AND ACCESSORIES



### Oven light

Included for Ökoalpin kitchen stoves with oven at the bottom and kitchen stoves with heat exchanger.  
Power connection required.

For all kitchen stoves with oven ..... 151,00 €



### Enameled baking tray

H= 39 mm ..... 82,00 €

H= 79 mm ..... 99,00 €



### Baking grid

..... 33,00 €



### Baking stone

Baking stone/ pizza stone to use inside the oven

..... 89,00 €

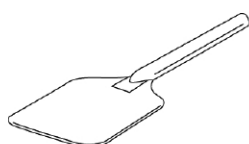

### Pizza shovel

..... 46,00 €

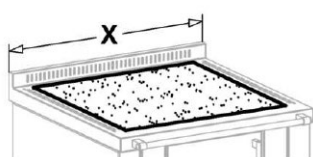

### Steel or glass-ceramic hob (additional or substitution)

For Ökoalpin kitchen stoves, kitchen stoves with heat exchanger and prefabricated kitchen stoves.

"X" up to 600 mm ..... 220,00 €

"X" over 600 mm ..... 315,00 €



### CAST IRON RINGS FOR STEEL HOB WITH DIAMETER OF 235 MM

Not available for glass-ceramic hob

..... 58,00 €

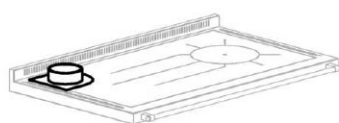

### Connection piece for smoke outlet on the top

For satin-finished steel hob or glass-ceramic hob

including adapter ..... 175,00 €

# CUSTOMIZATIONS

## AND ACCESSORIES

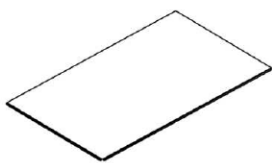

### Stainless steel hob cover

93,00 €



ST11 (serienmäßig)



ST04



ST21



ST31



ST35



ST37



ST41

### Dècor selection

Included with the dècor version. More options on request.

Dècor RAL-coloured coated or powder-coated in standard colours (per unit) 47,00 €

Dècor ST04, ST21, ST31, ST35, ST37, ST41 (per unit) 105,00 €



### Flexible, insulated connection pipe for external air supply

per meter 34,00 €

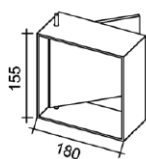

### Smoke diversion valve

For all kitchen stoves with oven (Ökoalpin BU on request) 482,00 €

For Ökoalpin 60 1.025,00 €

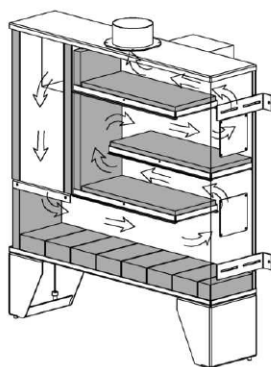

### Radiant wall

Can be used for kitchen stoves with the oven on either the right or the left side

Measurements (WxDxH): 900x207x975 mm (base version) 1.820,00 €

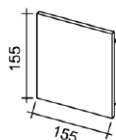

### Cleaning cover

Stainless steel, 155x155 mm 88,00 €



### Pressure monitor, pre-installed

Available in black or white 985,00 €

# WORKTOP CLOSURE

## PANELS AND SPACER STRIPS

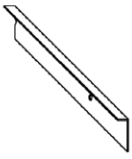

### L-shaped worktop closure panel with open front

In stainless steel (per unit) ..... 49,00 €

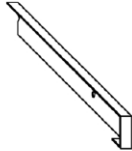

### L-shaped worktop closure panel with front cover

In stainless steel (per unit) ..... 75,00 €



### U-shaped spacer strips with air slots

In stainless steel, width 25 - 50 mm (per unit) ..... 109,00 €



### U-shaped spacer strips without air slots

In stainless steel, width 15 - 50 mm (per unit) ..... 83,00 €



### L-shaped spacer strip without air slots

In stainless steel, width 10 - 50 mm (per unit) ..... 62,00 €

# OPTIONALS

VINTAGE, PELLET AND PREFABRICATED KITCHENSTOVES ON REQUEST

## Other

Cladding with customer's tiles - side panel, per side	459,00 €
Cladding with customer's tiles - vertical front section, per side	222,00 €
Cladding with jointless, free-standing tile corner piece for furniture extensions, standard glaze, p	530,00 €
Cladding with jointless, heat-retaining tiled wall, free-standing, standard glaze, per side	790,00 €
Cladding with soapstone - side panel, per side	780,00 €
Cladding with soapstone - vertical front section, per side	420,00 €
Cladding with tiles - side panel, vertical front section and tile corner piece, per side	824,00 €
Cladding with tiles - sides panel, per side	680,00 €
Cladding with tiles - vertical front section, per side	320,00 €
Customized smoke outlet more than 200 mm from the rear edge (not applicable for the Ökoalpin BU kitc	531,00 €
Customized smoke outlet up to 200 mm from the rear edge (not applicable for the Ökoalpin BU kitchen	300,00 €
Design in nature steel (this material may have differences in structure and color)	394,00 €
Fire-, ash-, Panorama or oven door powder-coated (F1, F2, F5, F6, F9) (package)	198,00 €
Preparation for cladding with tiles - side panel, per side	214,00 €
Preparation for cladding with tiles - vertical front section, per side	130,00 €
Preparation for single-piece tiled wall for on-site fitting, per side	214,00 €
Rear side with AIR SYSTEM fire protection for integration in kitchen island (depth +20 mm)	638,00 €
Special RAL-coloured powder coatings - vertical front section / side panel - front drawer	394,00 €
Stainless steel water-heating container only for Ökoalpin 100 (with the Ökoalpin 80 oven)	1.008,00 €
Steel plate 10 mm for 110 Ökoalpin, 110 Vintage and 110 prefabricated stove	368,00 €
Steel plate 12 mm for 110 Ökoalpin, 110 Vintage and 110 prefabricated stove	494,00 €
Steel plate graphite painted (Warning: not scratch-proof)	147,00 €
Version cooking island, rear side in sight (depth +20 mm)	638,00 €



# PROFESSIONAL STOVES

- High efficiency combustion chamber
- Connection for external air intake
- Oven on right or left side
- Oven with or without double-pane glass door, incl. baking tray and grid
- Satin-finished steel hob 15 mm
- AIR SYSTEM fire protection
- Side panels in stainless steel
- Front railing
- Customized height
- Self-closing drawer with integrated baseboard



## 1100 Professional

- Device measurements (W x D x H) • 1.100 x 800 x auf Maß
- Nominal heating output • 10,0 kW
- Oven measurements (W x D x H) • 450 x 620 x 265 mm

Trend	8.465,00 €
Dekor	8.775,00 €
Panorama	8.815,00 €



## 1300 Professional

- Device measurements (W x D x H) • 1.300 x 800 x auf Maß
- Nominal heating output • 10,0 kW
- Oven measurements (W x D x H) • 550x 620 x 265 mm

Trend	8.945,00 €
Dekor	9.255,00 €
Panorama	9.295,00 €

# ACCESSORIES

## PROFESSIONAL STOVES

Bar for kitchen utensils	135,00 €
Cast iron rings for professional kitchen stoves, or steel hob-with thickness of more than 10 mm	160,00 €
Connection piece for smoke outlet on the top	174,00 €
Free-standing professional kitchen stove (depth to be increased by 50 mm), includes railing on all 4	956,00 €
Heat exchanger for hot water production	3.240,00 €
Increase of frame depth of more than 800 mm, per 100 mm depth/ per each meter width	184,00 €
Rectangular railing for professional kitchen stoves, per meter	180,00 €
Stainless steel back panel, per sqm	767,00 €
Stainless steel baking grid for 1100 Professional, Measures : 431x590 mm	122,00 €
Stainless steel baking grid for 1300 Professional, Measures: 531x590 mm	134,00 €
Stainless steel baking tray for 1100 Professional, Measures : 431x590x39 mm	167,00 €
Stainless steel baking tray for 1300 Professional, Measures : 531x590x39 mm	188,00 €

# CABINETS

IN STAINLESS STEEL OR POWDER-COATED STANDARD COLOURS  
INCLUDING WORKTOP AND BASE  
FURTHER CABINETS ON REQUEST: COLUMNS, WALL CABINETS, SLIDING DOORS

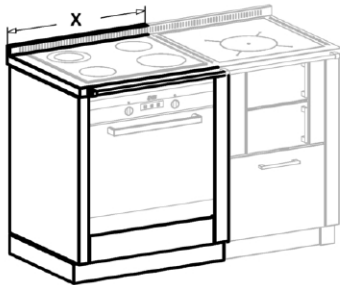

## Equipment extension for oven and resting/ top-mounted hob

- Built-in appliances not included in price
- Brand and model details/ measurements are required for accurate installation

Surcharge cut- for flush-fitted hob	260,00 €
Width 650 mm	1.255,00 €
Width 800 mm	1.545,00 €
Width 950 mm	1.835,00 €

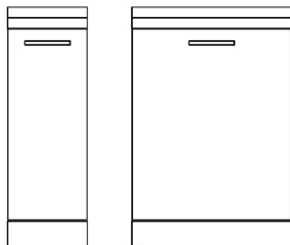

## Cabinet with 1 drawer

Bottle insert for cabinet with 1 drawer, width 300 mm	285,00 €
Width 300 mm	1.485,00 €
Width 600 mm	1.610,00 €



## Cabinet with 2 drawers

Width 300 mm	1.610,00 €
Width 600 mm	1.835,00 €
Width 900 mm	2.150,00 €
Width 1200 mm	2.460,00 €

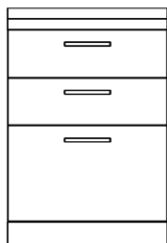

## Cabinet with 3 drawers

Width 300 mm	2.010,00 €
Width 600 mm	2.280,00 €
Width 900 mm	2.690,00 €
Width 1200 mm	3.095,00 €

# CABINETS

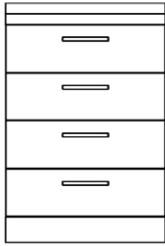

## Cabinet with 4 drawers

Width 300 mm	2.415,00 €
Width 600 mm	2.730,00 €
Width 900 mm	3.230,00 €
Width 1200 mm	3.730,00 €

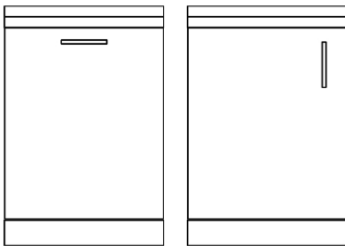

## Cabinet for kitchen appliances/ Cabinet with 1 door

Cabinet for dishwasher/fridge with front cover, width 600 mm	640,00 €
Cabinet with 1 hinged door, width up to 300 mm	1.105,00 €
Cabinet with 1 hinged door, width up to 600 mm	1.235,00 €

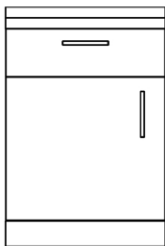

## Cabinet with 1 hinged door and 1 drawer

Width 300 mm	1.510,00 €
Width 600 mm	1.680,00 €

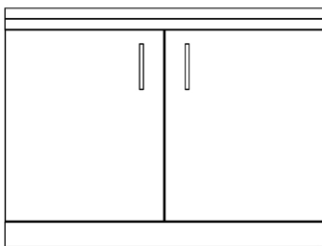

## Cabinet with 2 hinged doors

Width 900 mm	1.660,00 €
Width 1200 mm	1.790,00 €

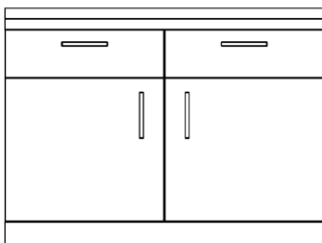

## Cabinet with 2 hinged doors and 2 drawers

Width 900 mm	2.555,00 €
Width 1200 mm	2.685,00 €

# CABINETS

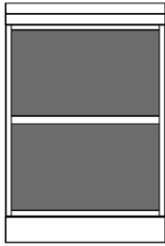

## Open cabinet with 2 compartments

Width 600 mm	1.070,00 €
Width 900 mm	1.245,00 €
Width 1200 mm	1.415,00 €

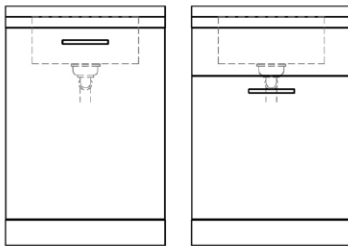

## Cabinet for sink with 1 drawer

Sink to be provided by the customer.  
Installation and welding of the sink included in the price.

Width 600 mm	2.010,00 €
With fixed cover, width up to 600 mm	2.145,00 €

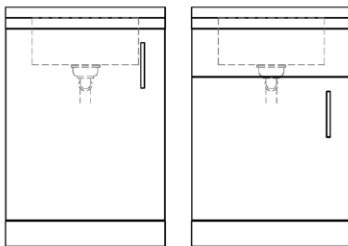

## Cabinet for sink with 1 hinged door

Sink to be provided by the customer.  
Installation and welding of the sink included in the price.

Width 600 mm	1.630,00 €
With fixed cover, width 600 mm	1.770,00 €

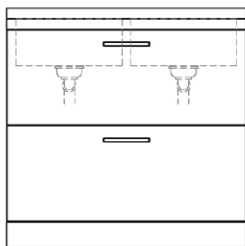

## Cabinet for double sinks with 2 drawers

Sink to be provided by the customer.  
Installation and welding of the sink included in the price.

Width up to 900 mm	2.720,00 €
Width up to 1200 mm	3.035,00 €

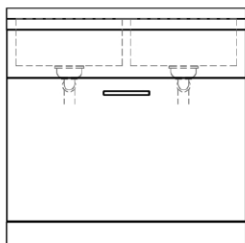

## Cabinet for double sinks with 1 drawer and fixed cover

Sink to be provided by the customer.  
Installation and welding of the sink included in the price.

Width up to 900 mm	2.450,00 €
Width up to 1200 mm	2.575,00 €

# CABINETS

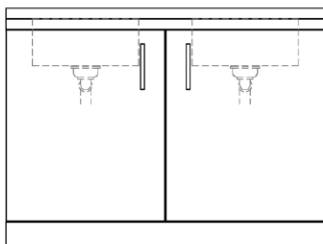

## Cabinet for double sinks with 2 hinged doors

Sink to be provided by the customer.  
Installation and welding of the sink included in the price.

Width up to 900 mm ..... 2.230,00 €

Width up to 1200 mm ..... 2.360,00 €

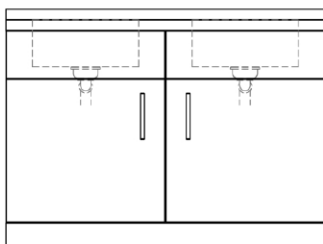

## Cabinet for double sinks with 2 hinged doors and fixed cover

Sink to be provided by the customer.  
Installation and welding of the sink included in the price.

Width up to 900 mm ..... 2.505,00 €

Width up to 1200 mm ..... 2.635,00 €

# OPTIONALS

## CABINETS

Additional drawer for cabinet, width up to 1200 mm	635,00 €
Additional drawer for cabinet, width up to 300 mm	402,00 €
Additional drawer for cabinet, width up to 600 mm	449,00 €
Additional drawer for cabinet, width up to 900 mm	541,00 €
Additional hinged door for cabinet, width up to max. 600 mm	298,00 €
Conection cover / panel between cabinets	100,00 €
Cut-out for flush-fitted hob	372,00 €
Cut-out for resting/ top-mounted hob	112,00 €
Double flush sink, welding included, measures (BxTxH): 840x400x215 mm	2.225,00 €
Flush sink, welding included, measures (BxTxH): 340x400x215 mm	1.120,00 €
Flush sink, welding included, measures (BxTxH): 400x400x215 mm	1.145,00 €
Flush sink, welding included, measures (BxTxH): 500x400x215 mm	1.175,00 €
Flush sink, welding included, measures (BxTxH): 700x400x215 mm	1.225,00 €
Flush sink, welding included, measures (BxTxH): 800x400x215 mm	1.250,00 €
Height-adjustable shelf, width up to 1200 mm	224,00 €
Height-adjustable shelf, width up to 600 mm	131,00 €
Height-adjustable shelf, width up to 900 mm	178,00 €
Increase of cabinet depth in excess of 800 mm, per 100 mm, per unit	190,00 €
Side panel for free-standing cabinets, per side	219,00 €
Surcharge for handleless doors or drawer, per unit	59,00 €
Welding/ installation of double sink or sink with drain (sink to be provided by the customer)	572,00 €
Welding/ installation of sink with one basin (sink to be provided by the customer)	398,00 €



# TAILOR-MADE STOVES

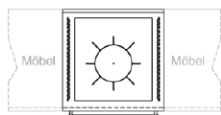

## Tailor-made stoves without oven

Width starting from 400 mm

starting from 3.855,00 €

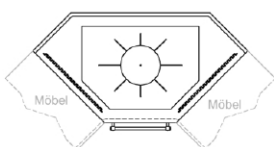
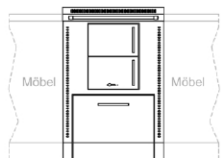

## Angular-tailor-made stoves without oven

Thigh dimension starting from 850x850 mm

starting from 4.830,00 €

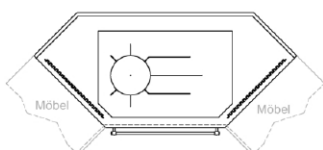
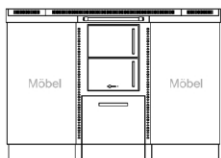

## Angular-tailor-made stoves with oven

Thigh dimension starting from 1120x1120 mm

starting from 6.325,00 €

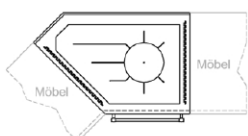
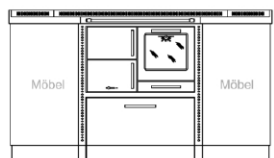

## Single-angle tailor-made stoves without oven

Front width starting from 380 mm

starting from 4.790,00 €

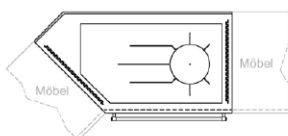
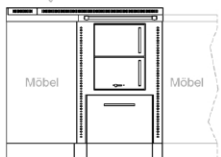

## Single-angle tailor-made stoves with oven

Front width starting from 750 mm

starting from 5.955,00 €

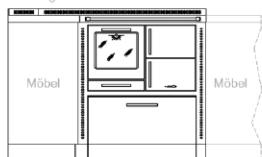

# COMPONENTS

## FOR STOVES

### STEEL HOBS

- Satin-finished steel hob
- With one ring  $d=235$  mm and expansion gaps
- Position of the ring selectable (measure X,Y)

#### SURCHARGES

Round gasket (ceramic), per mt: 11,60 €  
 Rings,  $d= 235/280/320$  mm: starting from 58,00 €  
 Milling of the steel hob: 555,00 €

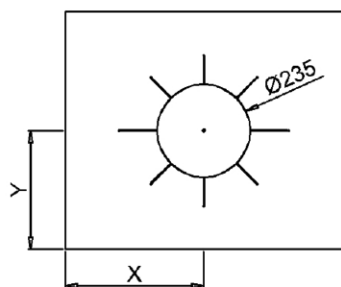

### Satin-finished steel hob 8, 10, 12, 15, 20 mm

to size, per cm<sup>2</sup>

starting from 0,14 €

### HIGH EFFICIENCY COMBUSTION CHAMBER CERTIFIED

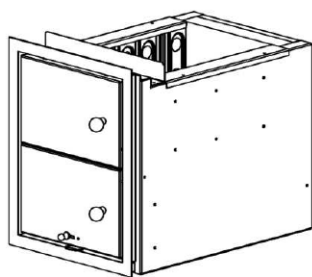

### Trend version completely with combustion chamber

Surcharge Dècor selection, per unit: 105,00 €

1.658,00 €

### OVENS

Surcharge Dècor selection, per unit: 105,00 €

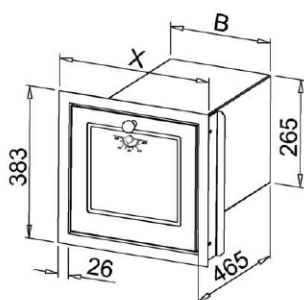

### Oven with removable maintenance bottom

- Mounting brackets adjustable
- with double-pane glass and thermometer
- incl. baking tray and grid

Standard measurements:  
 Oven width inside (B):  
 262, 304, 347 or 447 mm  
 Overall width (X):  
 396, 438, 481 or 581 mm

1.041,00 €

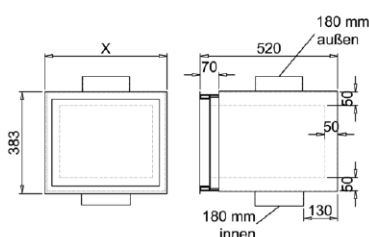

### Prefabricated gas pass system

incl. oven with removable maintenance bottom

1.862,00 €

# EXTRACTOR HOODS



## Diagonal

Width up to 900 mm	2.054,00 €
Width up to 1250 mm	2.172,00 €
Width up to 1550 mm	2.290,00 €
Width up to 1850 mm	2.412,00 €
Width up to 2150 mm	2.530,00 €



## Line

Width up to 900 mm	1.881,00 €
Width up to 1250 mm	1.993,00 €
Width up to 1550 mm	2.104,00 €
Width up to 1850 mm	2.239,00 €
Width up to 2150 mm	2.351,00 €



## Classic

Width up to 900 mm	1.881,00 €
Width up to 1250 mm	1.993,00 €
Width up to 1550 mm	2.104,00 €
Width up to 1850 mm	2.239,00 €
Width up to 2150 mm	2.351,00 €



## Camino

Width up to 900 mm	1.881,00 €
Width up to 1250 mm	1.993,00 €
Width up to 1550 mm	2.104,00 €
Width up to 1850 mm	2.239,00 €
Width up to 2150 mm	2.351,00 €



## Sky

900 mm	2.357,00 €
1200 mm	2.508,00 €
1500 mm	2.781,00 €
1800 mm	3.056,00 €
2100 mm	3.324,00 €

# EXTRACTOR HOODS



## Sky Incasso

900 mm	1.836,00 €
1200 mm	2.010,00 €
1500 mm	2.182,00 €
1800 mm	2.362,00 €
2100 mm	2.541,00 €



## Evo Incasso

531 mm	581,00 €
776 mm	615,00 €
1053 mm	722,00 €

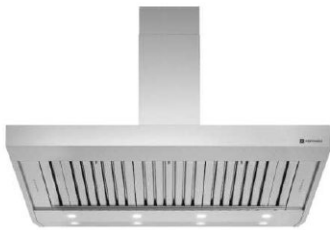

## Professional Wall

Width from 850 mm	2.357,00 €
Width from 1200 mm	2.535,00 €
Width from 1550 mm	3.285,00 €
Width from 1900 mm	3.464,00 €
Width from 2250 mm	3.660,00 €
Width from 2600 mm	3.851,00 €
Width from 2950 mm up to 3150 mm	4.046,00 €

# REMOTE

## MOTORS



### Built-In motor

1.051,00 €



### External extractions

1.859,00 €

# OPTIONALS

## EXTRACTOR HOODS

Active carbon filter	44,00 €
Additional exhaust pipe	415,00 €
Customized front section	172,00 €
Cut-out for chimney flue of the kitchen stove	340,00 €
Exhaust pipe not centered	348,00 €
Fixed position chimney cover	120,00 €
Insert powder-coated special RAL (model Line)	393,00 €
Insert powder-coated standard colours (model Line)	112,00 €
Powder-coated (standard colours) extractor hood (model Classic and Camino)	224,00 €
Powder-coated special RAL extractor hood (model Classic and Camino)	393,00 €
Remote control for extractor hood	66,00 €

# OVENS



## 60 SIEMENS - 7 types of heating

Telescope guide rail: 198,00 €

----- 919,00 €



## 60 SIEMENS - 13 types of heating

----- 1.493,00 €



## 90 SIEMENS - 10 types of heating

----- 2.022,00 €

# HOBS



## 60 SIEMENS ELECTRIC HOB

Flat frame design

----- 609,00 €

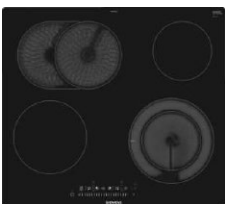

## 60 SIEMENS ELECTRIC HOB

Flush fitted design

----- 737,00 €

# HOBS



## 60 SIEMENS INDUCTION HOB

Flat frame design

1.237,00 €



## 60 SIEMENS INDUCTION HOB

Flush-fitted design

1.237,00 €

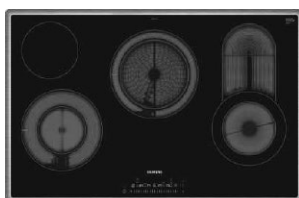

## 80 SIEMENS ELECTRIC HOB

Flat frame design

1.094,00 €

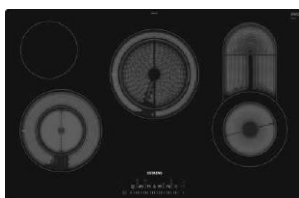

## 80 SIEMENS ELECTRIC HOB

Flush fitted design

1.094,00 €



## 80 SIEMENS INDUCTION HOB

Flat frame design

1.576,00 €

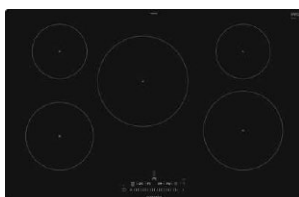

## 80 SIEMENS INDUCTION HOB

Flush-fitted design

1.576,00 €

# FLUE PIPES

2MM, MALE END



## Flue pipe 1000 mm

Diameter 120 mm ..... 59,00 €

Diameter 150 mm ..... 62,00 €



## Flue pipe 500 mm

Diameter 120 mm ..... 42,50 €

Diameter 150 mm ..... 45,00 €



## Flue pipe 250 mm

Diameter 120 mm ..... 32,00 €

Diameter 150 mm ..... 34,00 €



## Flue pipe 0-90° bend, adjustable with door

Diameter 120 mm ..... 59,50 €

Diameter 150 mm ..... 63,50 €



## Flue pipe 0-45° bend, rotatable without door

Diameter 120 mm ..... 52,00 €

Diameter 150 mm ..... 54,50 €



## Flue pipe 90° bend with door

Diameter 120 mm ..... 57,50 €

Diameter 150 mm ..... 61,50 €



## Flue pipe 45° bend with door

Diameter 120 mm ..... 51,00 €

Diameter 150 mm ..... 54,00 €



## Flue pipe with valve, length of 250 mm

Diameter 120 mm ..... 55,00 €

Diameter 150 mm ..... 56,50 €



# FLUE PIPES

2MM, MALE END



## Twin wall double socket adaptor

Diameter 150 mm ..... 23,50 €

Diameter 120 mm ..... 23,50 €



## Standard trim ring

Diameter 150 mm ..... 22,00 €

Diameter 120 mm ..... 22,00 €



## Flue pipe bracket

Diameter 150 mm ..... 18,50 €



## Bracket for smoke pipe

Pipe clamp with grup screw and hanger bolt, d= 120 mm ..... 27,50 €

Pipe clamp with grup screw and hanger bolt, d= 150 mm ..... 31,50 €

# FLUE PIPES

FOR PELLETT STOVES



## Flue pipe 1000 mm

Diameter 80 mm

59,00 €



## Flue pipe 500 mm

Diameter 80 mm

42,00 €



## Flue pipe 250 mm

Diameter 80 mm

26,50 €



## Flue pipe 45° bend

Diameter 80 mm

57,50 €



## Flue pipe 90° bend with door

Diameter 80 mm

78,00 €



## Twin wall double socket adaptor

Ring diameter 80 mm

22,00 €

Diameter 80 mm

23,50 €

# CLEANING

## AND MAINTENANCE PRODUCTS



### P-Biocleaner

Single piece	12,40 €
Single piece	12,40 €
Pack of 10 pcs.	124,00 €



### P-Clean Plus

Single piece	11,70 €
Pack of 6 pcs.	70,00 €



### P-Oil Protection

Single piece	7,40 €
Pack of 10 pcs.	74,00 €



### P-Orange Degreaser

Single piece	7,40 €
Pack of 10 pcs.	74,00 €



### P-Protect Oxidation

Single piece	15,00 €
Pack of 12 pcs.	180,00 €

# CLEANING

## AND MAINTENANCE PRODUCTS



### P-Shine Inox

Single piece	8,20 €
Pack of 10 pcs.	82,00 €



### P-Clean Stone

Single piece	12,40 €
Pack of 12 pcs.	148,00 €



### P-Vacuurr

Ash vacuum cleaner 800W - PROMOTION (net price)	27,00 €
---	---------



### P-Eco Fire

Eco-wood wool igniter, pack of 48 pcs.	5,00 €
--	--------



# GENERAL TERMS

## AND CONDITIONS

### **ORDER ACCEPTANCE**

Every order will be valid exclusively upon written confirmation by the Seller. These General Terms and Conditions are an integral part of the order.

### **DELIVERY TERMS**

The Seller reserves the right, for any order accepted, to withdraw from the obligation of delivery, totally or partially, for reasons of force majeure or for other reasons outside the Seller's control and which render executing and fulfilling the order impossible. The Seller commits to respecting the agreed delivery terms. However, eventual delays in delivery do not entitle the Buyer to withdraw from the contract and to demand an alternative supply or any other form of compensation.

### **TRANSPORT**

All prices must be considered ex-works. In the case of delivery by the Seller's staff and vehicles or if transport is arranged by the Seller, the price of transport and packaging will be charged and listed separately in the invoice. All prices for transport and packaging are to be considered as net prices.

### **DRAWINGS, SKETCHES, PROTOTYPES AND SAMPLES**

Drawings, sketches, prototypes and samples cannot be copied, duplicated or made available to third parties without explicit written authorization and remain property of Pertinger Srl unless explicitly and separately invoiced and paid for.

### **CLAIMS**

Any defects or imperfections of the material, with precise indication of the causes, must be communicated to the Seller by registered mail within 8 days from the day of delivery. Small differences or discrepancies in the final product, such as finish, weight, quality and colours of the materials, might be possible given the artisan workmanship and, in any case, do not entitle the Buyer to a claim as long as the Seller's quality standards are met. Requests for damage compensation are excluded. Product warranty is governed by current laws and regulations. The local dealer commits to repair all appliances and carry out the work under warranty; related costs are covered by the Seller only with previous explicit and written authorization.

### **PRELIMINARY AND/OR ACCESSORY WORK**

The flue must meet existing regulations of the country of installation and must be tested by a qualified technician. All the adjacent walls to the wood-burning oven must be made of fireproof material. Extra work such as: installation, electrical, building and any channeling are at the expense of the Buyer. Gas and electricity connections must be performed by dedicated professionals.

### **MODIFICATIONS**

Work not planned or included in the order, successive modifications and additional transfers of fitters, requested by the Buyer, will be invoiced based on the cost of material and required labour.

### **PAYMENT**

The Buyer completes all payments in a timely and complete way. If the payment terms and conditions are not respected, additional rates, such as administrative costs and interest for arrears, will be applied.

### **OWNERSHIP RESERVATION**

All goods supplied remain the property of Pertinger Srl until they have been paid for in full. The risk and liability are transferred to the Buyer at the time of delivery. The Buyer recognizes full rights to the Seller to enter the locations where the goods are situated. If the right to reclaim property is exercised, all related costs will be charged to the Buyer. Any foreclosures must be promptly communicated.

### **ACCEPTANCE**

The General Terms and Conditions as stated in this document become effective at the moment of the order acceptance and prevail, without any exception, any other General Buying Conditions of the Buyer.

### **APPLICABLE LAW AND JURISDICTION**

The contract and the General Terms and Conditions are governed by the Italian law. Any dispute regarding the contract or these General Terms and Conditions, which cannot be settled amicably, shall be instituted in the Court of Bolzano. The Buyer and Pertinger Srl agree to submit to the jurisdiction of, and agree that venue is proper in, this court in any such legal action or proceeding.

# VARIATIONS

## HOB VARIATIONS:



Glass-ceramic hob



Satin-finished stainless steel with one ring with single circle



Satin-finished stainless steel with rings



Summer covering plate

## OVEN VARIATIONS:



Oven door with glass



Oven door with glass and inside light

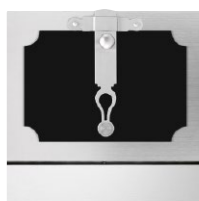

Oven door with decor



Lateral opening oven door

## FIRE DOOR VERSION:



PANORAMA



TREND

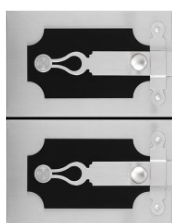

DEKOR

## DEKOR VERSION:



ST04



ST21



ST31



ST35



ST37



ST41

## STANDARD COLOURS AND FINISHES



Satin-finished stainless steel



Rendered



Silver black F1



Grey brown F2

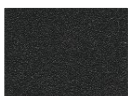

Absolute black F5



Burgundy F6

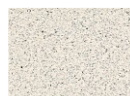

Sand F7

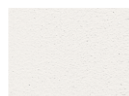

White F8

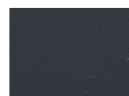

Anthracite F9

## OPTIONAL:



Natural steel



Majolica or tiles



Soapstone



RAL

## HANDLE AND HANDLERAIL VARIATIONS:



G01



G02



G03



G05



RH01



RH03



RH05



RH02



RH04



RH06



**PERTINGER** S.r.l.

Via Plattner, 2 • 39040 Varna  
BZ • Alto Adige • ITALY

**T** +39 0472 849525 • **F** +39 0472 849680

**E** info@pertinger.com • **W** pertinger.com

A company from  
**SÜDTIROL**

